

New 45° General Purpose Milling Series

**MB45****NEW****Extremely versatile, high performance, high quality, and long tool life milling**

Delivers the “low cutting force” benefits of positive inserts and the “fracture resistance” benefits of negative inserts, and provides excellent surface finish

Next-generation PVD coating for milling PR18 Series

Extended lineup of inserts and grades

Supports a wide variety of machining applications, including steel, stainless steel, cast iron, aluminum alloys, and heat-resistant alloys

Innovative new holder design



# MB45

Provides high quality and high performance machining solutions with long tool life  
Delivers the “low cutting force” benefits of positive inserts and the “fracture resistance” benefits of negative inserts, and provides excellent surface finish

## Extreme versatility

General-purpose milling cutters require a balance between high-quality, high-performance, long tool life, economy, and versatility to be able to tackle a wide variety of machining applications

Pursue all of these qualities without compromising with the MB45

These next-generation cutters will last, whether you are running general machining applications, or finding valuable new machining solutions

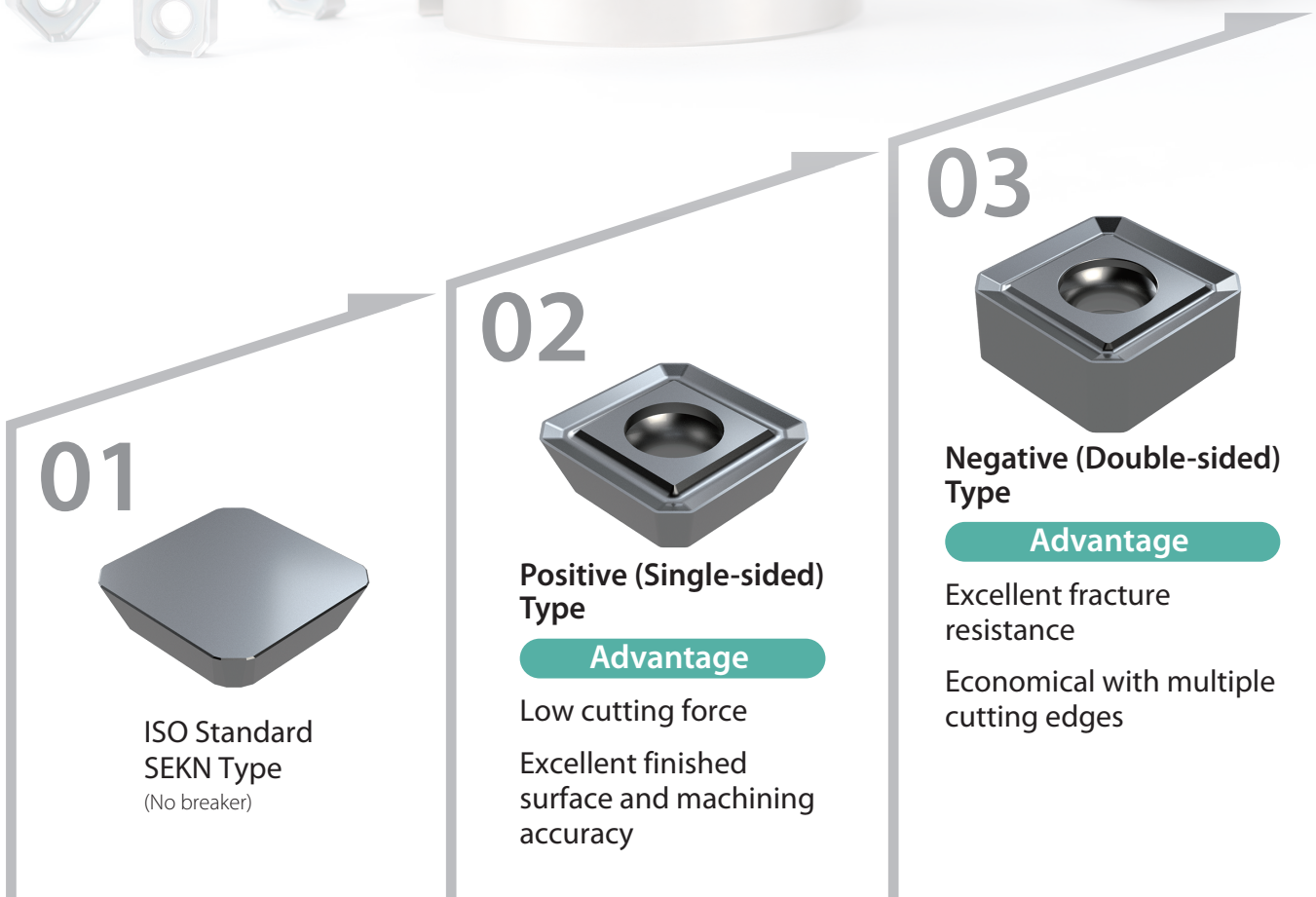

## Evolving to standardize new technology

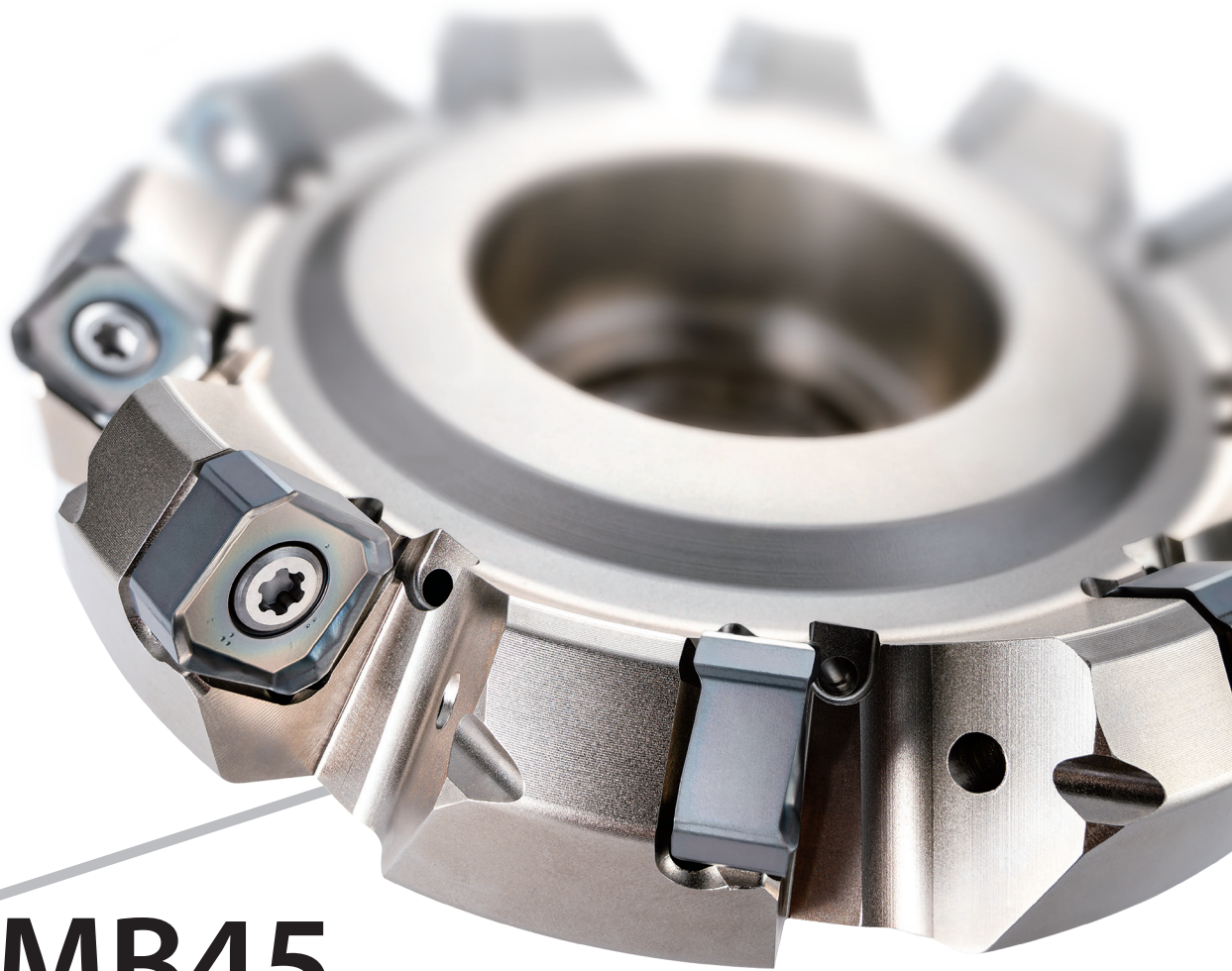

# 04 MB45

Delivers the “low cutting force” benefits of positive inserts and the “fracture resistance” benefits of negative inserts

## High Quality

High quality results and excellent surface finish

- Lineup of E class inserts
- Long arc wiper edge
- Back coolant hole

## High Performance

Unique design with high performance, low cutting force and fracture resistance

- Double edge structure and helical cutting edge (A.R. max + 13°)

## Long Tool Life

Next-generation PVD coating for milling PR18 Series

**NEW**

- Double lamination technology maintains longer tool life
- Double-sided 8-corner design reduces tool costs

## Solution

Find new value with excellent versatility

- Integrated tooling: Roughing and finishing with E class inserts
- For a wide variety of machining applications: Small machines (BT30, etc.) with  $\varnothing 40\text{mm}$  cutter
- For a variety of workpieces: Cost-cutting with multiple cutting edges for aluminum machining
- Enhanced Quality: Gain excellent surface finish with Cermet inserts (TN620M)

# 1 "Versatility" + "Quality" Large insert lineup Supports a wide variety of machining applications

Five types of inserts for various machining applications

Economical inserts with 8 cutting edges

General purpose GM insert with E-Class and M-Class options based on required machining accuracy

Video



## Low cutting force **SM** (E-Class)

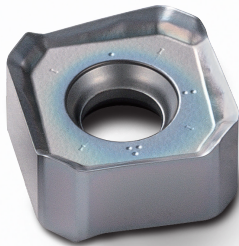

Sharpness oriented with a low cutting force design  
-10% cutting resistance compared to general purpose GM insert  
Recommended for small machines (BT30)

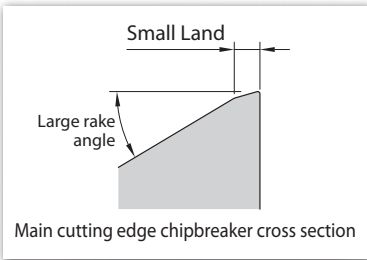

## General **GM** (E-Class / M-Class)

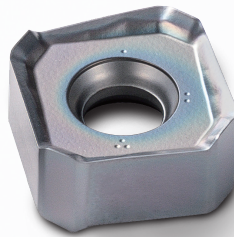

1st recommendation for steel machining  
Low cutting force and fracture resistance  
E-Class or M-Class selectable

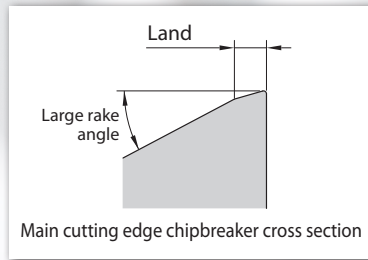

## Tough Edge **GH** (M-Class)

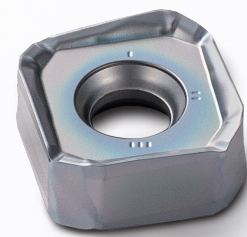

Tough cutting edge and excellent fracture resistance  
Obtuse edge design is resistant to chipping  
Recommended for intermittent machining

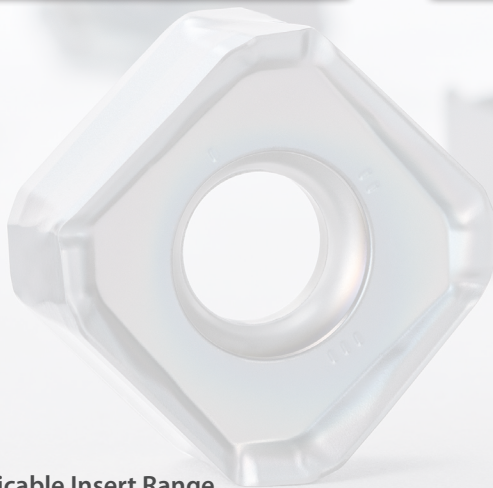
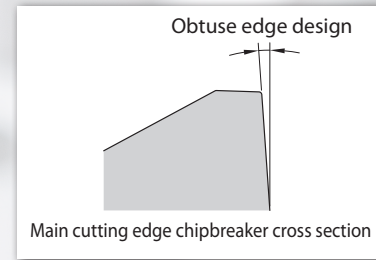

## AM for Aluminum Alloys

No Land + Sharp Edge Specifications  
Excellent sharpness

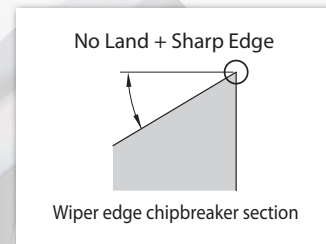
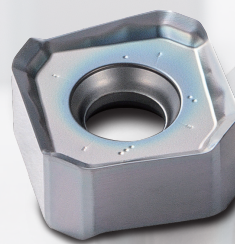

### Applicable Insert Range

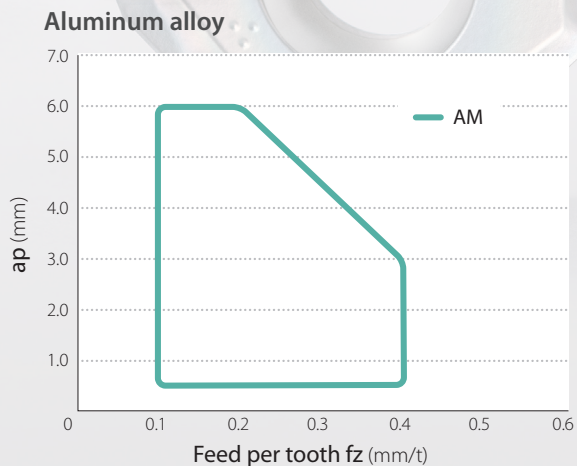
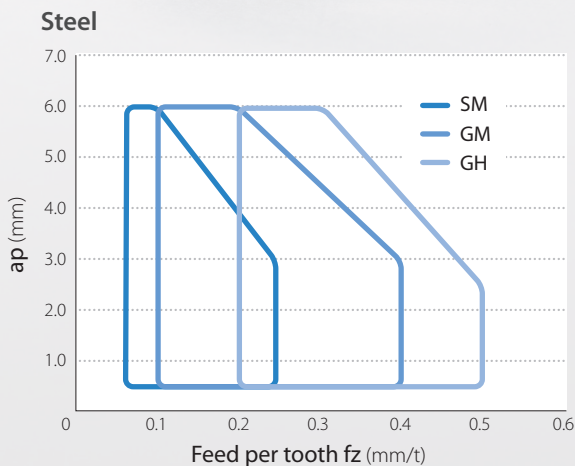

## When to use GM (Class E/M)

Selection by machining application    Surface roughness oriented: GM (E-Class)  
 Cost-effective and surface finish oriented: GM (M-Class)

| Criteria             | GM (E-Class)                                    | GM (M-Class)                                   |
|----------------------|---|--|
| Tolerance            | Inscribed Circle Tolerance $\pm 0.013\text{mm}$ | Inscribed Circle Tolerance $\pm 0.05\text{mm}$ |
| Surface finish       | ○ Approx. $1.6\mu\text{mRa}$                    | △ Approx. $3.2\mu\text{mRa}$                   |
| (Gloss)              | (○)   | (◎)  |
| Machining efficiency | ○   | ○  |
| Economy              | ○   | ◎  |

\*Surface finish is based on internal assessment and varies depending on the machining environment

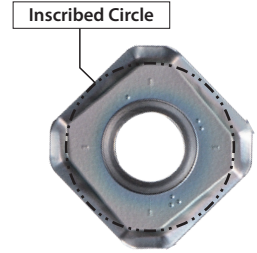

## Solution Tool integration for roughing and finishing with E-Class insert

**MB45**

Tool integration for roughing and finishing  
 Reduced tool management and inventory costs

Video



Roughing  $ap = 2.5 \text{ mm}$

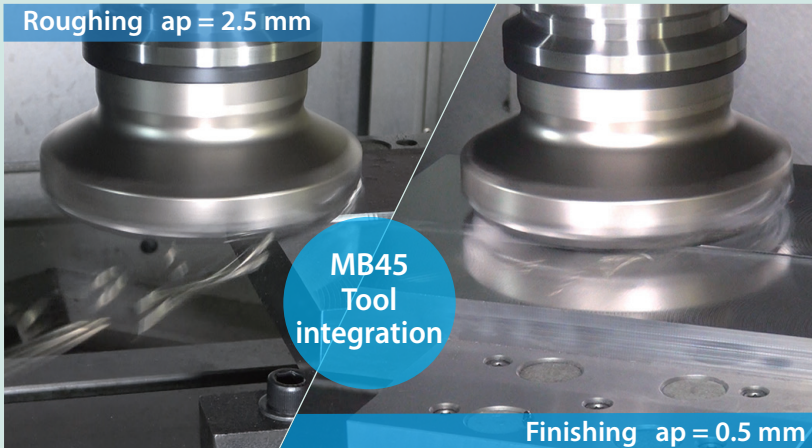

Finishing  $ap = 0.5 \text{ mm}$

Chip condition

Good chips in both roughing and finishing

Roughing



Finishing



Cutting Conditions:  $\phi 125$  (10 inserts) GM (E-Class) Dry Workpiece: S50C  
 Roughing:  $V_c = 200 \text{ m/min}$ ,  $ap \times ae = 2.5 \times 85 \text{ mm}$ ,  $fz = 0.20 \text{ mm/t}$   
 Finishing:  $V_c = 250 \text{ m/min}$ ,  $ap \times ae = 0.5 \times 85 \text{ mm}$ ,  $fz = 0.15 \text{ mm/t}$

Finished surface condition

Excellent surface finish



Conventional machining

Tool replacement is needed when roughing and finishing

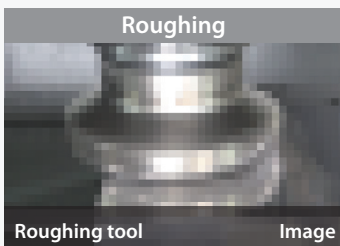

+



(Internal evaluation)

2

“Versatility” + “Long tool life” 7 insert grades

Steel, stainless steel, cast iron, heat-resistant alloys to aluminum alloy machining

For steel, stainless steel and cast iron 

**PR1825/PR1835/PR1810** New development MEGACOAT NANO EX

For stainless steel and heat-resistant alloys 

**CA6535** CVD coating

For aluminum machining 

For steel Surface finish oriented 

**PDL025** DLC coating

**TN620M** Cermet

**GW25** Non-coated Carbide

Next-generation PVD coating for milling 

# PR18 Series

Kyocera’s Nano Layer Coating Technology. Longer Tool Life with Next-generation Coating for Milling



**MEGACOAT**  
**NANO EX** | Milling |

**Double Lamination Technology**  
**Maintains Longer Tool Life**

Multi-layer structure with two unique nano layers  
Superior abrasion resistance and fracture resistance

## Double lamination technology with special nano layer

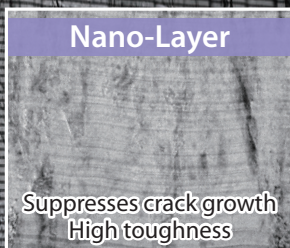

**AlCr-based coating**  
with excellent abrasion resistance

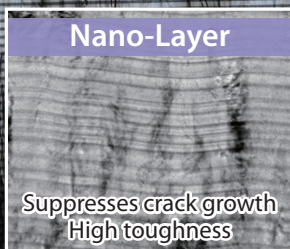

**AlTi-based coating**  
with excellent heat resistance

**Multi-layering of high-performance nano layers**

Increases toughness with the suppression of crack growth and optimization of internal stress

CG Image

Coating characteristics (Internal evaluation)

# MEGACOAT NANO EX | Milling |

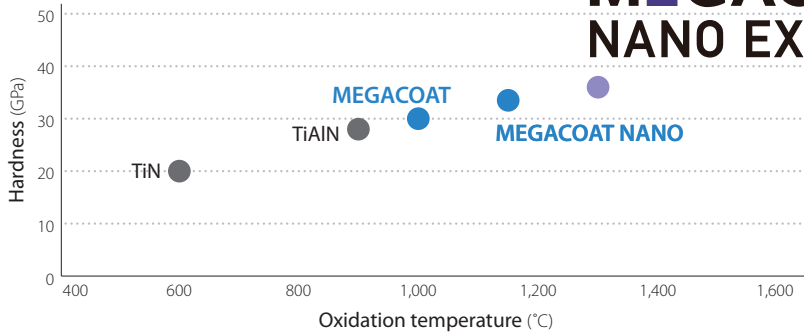

PR1825 with PVD coating MEGACOAT NANO EX provides long tool life

Wear resistance comparison (Internal evaluation)

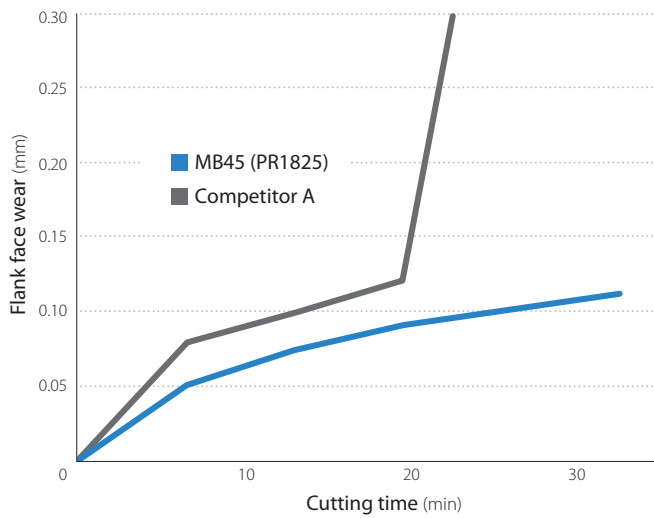

Cutting edge condition (after 20 min machining)

MB45(PR1825)

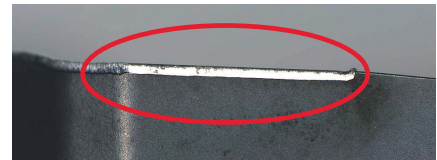

Competitor A



Cutting Conditions:  $V_c = 120$  m/min,  $a_p = 2.0$  mm,  $a_e/DC = 80\%$ ,  $f_z = 0.20$  mm/t, Dry  
Workpiece: SKD11,  $\phi 125$  BT50

## Solution Utilizing Cermet TN620M

Cermet (TN620M) for efficient finishing

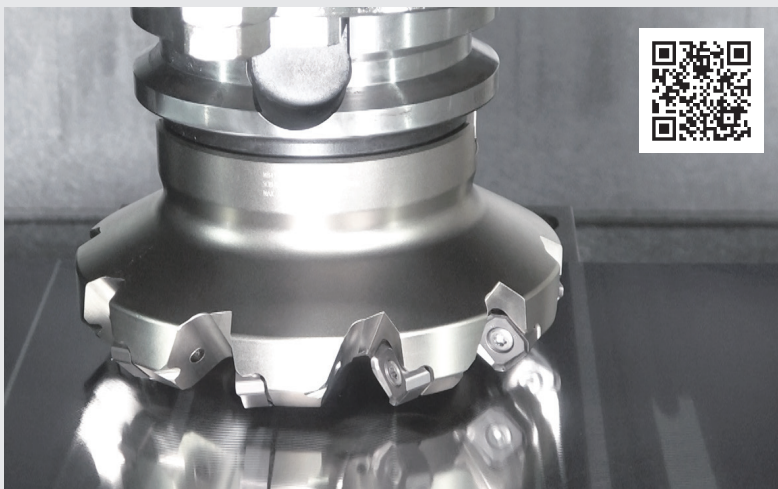

Surface finish condition (Internal evaluation)

Superior surface finish

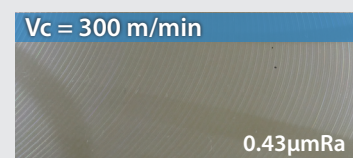
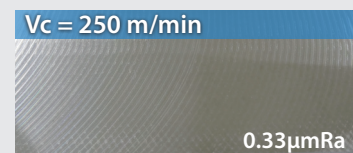
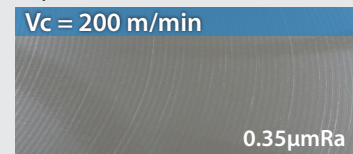

Cutting Conditions:  $a_p \times a_e = 0.5 \times 100$  mm  
 $f_z = 0.15$  mm/t, Dry  
Workpiece: S50C,  $\phi 125$  (10 inserts), GM (TN620M)

3

“Versatility” + “High Performance” New design utilizes unique technology  
 Low cutting force and excellent fracture resistance with excellent surface finish

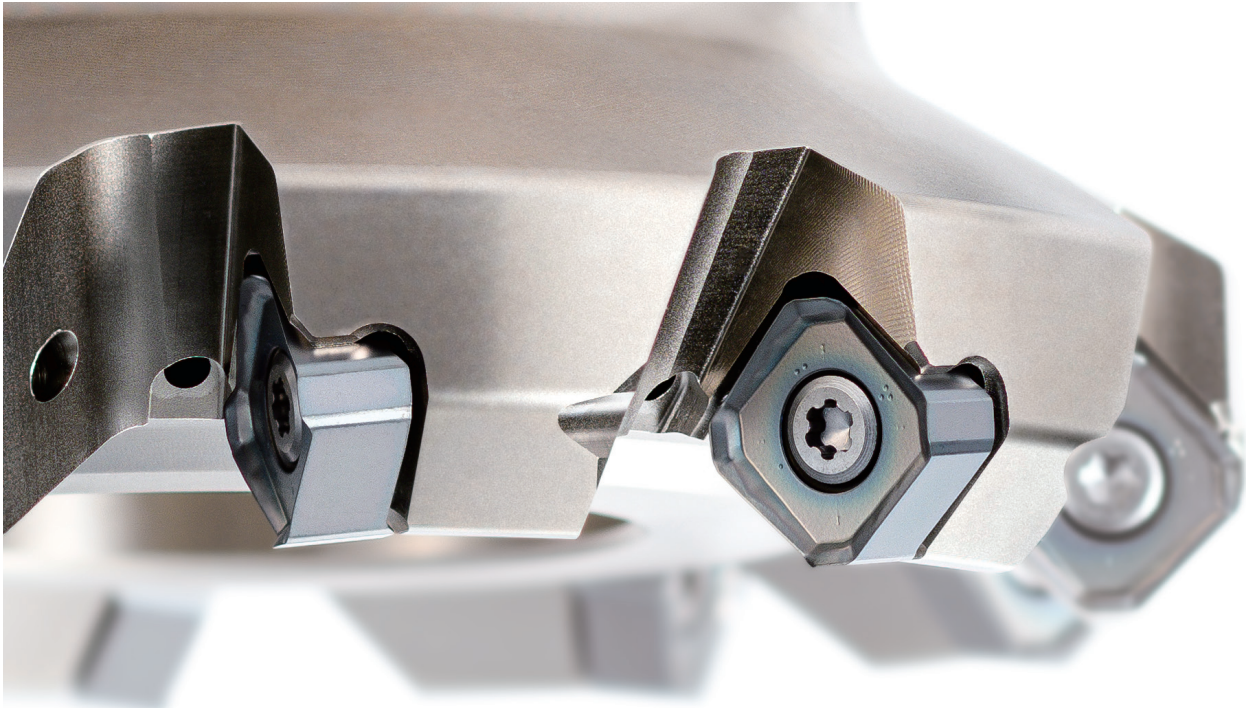

Low cutting force and excellent fracture resistance

Unique helical cutting edge and double-edge structure

**A unique helical cutting edge**

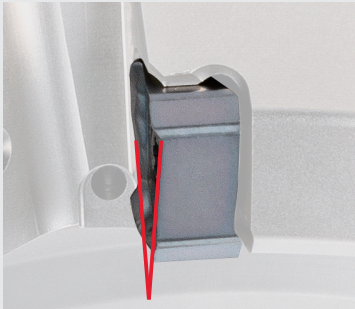

A.R. Ensures a maximum of 13° and suppresses chatter with low cutting force.

**Double edge structure**

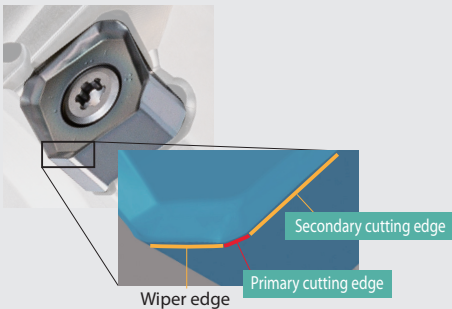

Primary cutting edge generates thin chips  
 Reduces impact load and greatly reduces vibration when exiting the part

**Cutting resistance comparison** (Internal evaluation)

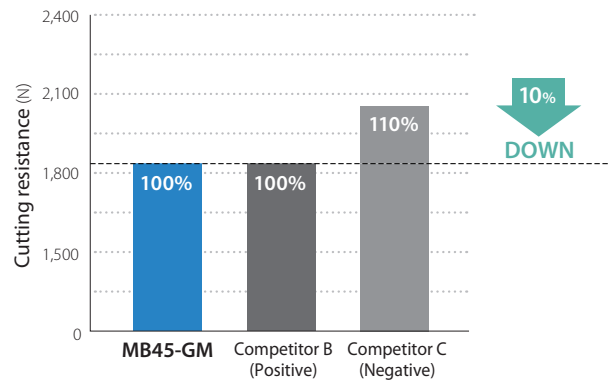

Cutting Conditions:  $V_c = 180$  m/min,  $a_p = 3.0$  mm,  $a_e/DC = 80\%$  Center Cut,  $f_z = 0.30$  mm/t, Workpiece: S50C

**Fracture resistance comparison** (Internal evaluation)  $f_z = 0.5\sim 0.8$  mm/t

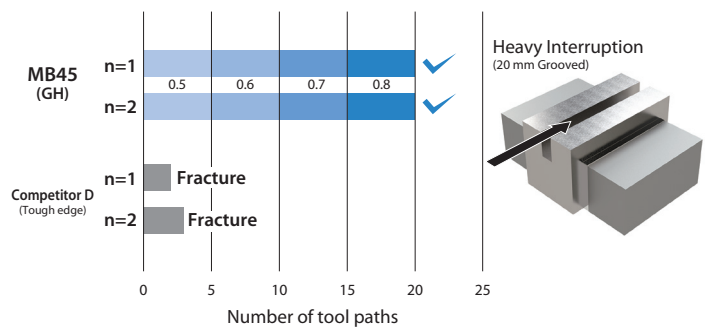

Cutting Conditions:  $V_c = 100$  m/min,  $a_p \times a_e = 2 \times 100$  mm Center Cut, BT50 Workpiece: SCM440HT  $\phi 125$  (10 inserts)



## High quality

## Long arc wiper edge utilizing unique technology

### Unique long arc wiper edge

Reduces variation in mounting accuracy and provides superior finished surface quality

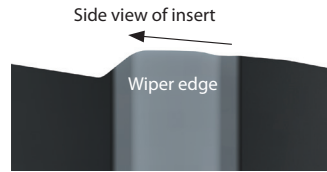

Convex curved shape with wiper edge protruding upward  
\*GM/SM/AM (E-Class)

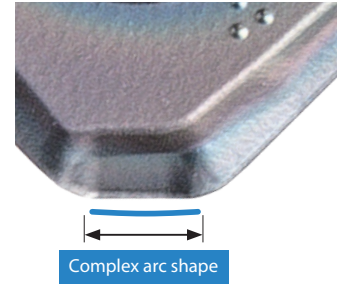

### Surface roughness comparison (Internal evaluation)

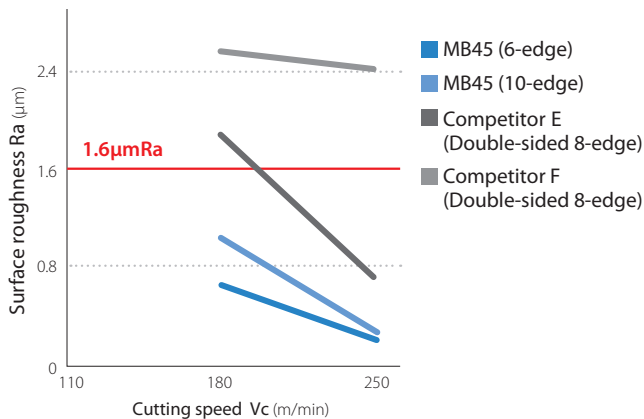

Cutting Conditions:  $a_p = 1.0 \text{ mm}$ ,  $a_p \times a_e = 1 \times 100 \text{ mm}$  (Center Cut),  $f_z = 0.20 \text{ mm/t}$ , Dry  
Workpiece: S50C  $\phi 125$  (6 inserts/10 inserts) GM (PR1825) BT50

### Finishing surface condition ( $V_c = 250 \text{ m/min}$ )

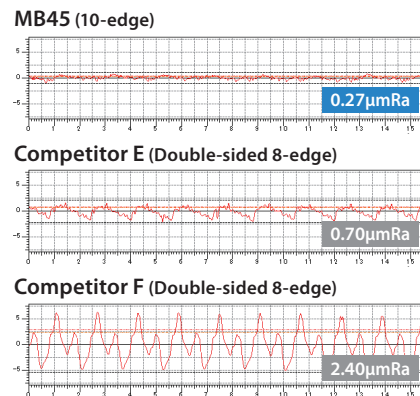

Proprietary long arc wiper edge provides excellent finishing surface quality

### Finishing surface quality comparison (Image)

#### MB45

##### Long arc wiper edge

Smooth finished surface with small feed joints



#### General insert

##### Straight wiper edge

The feed joint is large and the finished surface is stepped.



## Solution Unique back coolant structure delivers excellent finished surface.

Smooth chip evacuation reduces scratches and chip clogging on finished surfaces

Reliably supplies coolant to the cutting edge. Internal coolant allows for even higher quality surface finish

### Unique back coolant structure

#### Coolant hole

Mounted closer to the cutting edge than before  
Control chip outward for excellent chip evacuation to ensure to cool the cutting edge (up to  $\phi 125$ ).

#### Special grooves in the discharge port



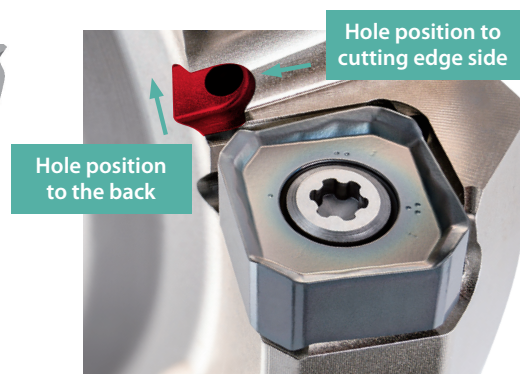
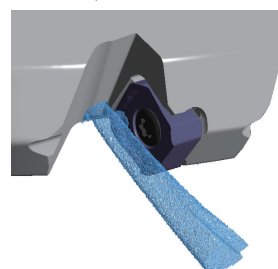

The hole position is on the far side to prevent chip contact  
Improves deterioration of chip control and evacuation

\* Due to shape restrictions, some toolholders do not have grooves in the discharge port.

Fluid analysis (image)



# Toolholder Lineup

| Coarse pitch   | Fine pitch  | Extra fine pitch   | Shank Type   |
|--|---|--|--|
|                           |    |  |   |
| Recommended for workpieces or machines with low rigidity (such as sheet machining or BT30)<br>Economical   | <b>1st recommendation</b><br>Good balance of stability, machining accuracy and efficiency<br>Supports a wide range of machining areas | Recommended for high rigid workpiece and machine                                   | Compatible with milling chucks (face mill recommended basically)<br>*Shank size: ø32 |
| Cutting diameter ø80 to ø315 (inch spec)<br>Cutting diameter ø40 to ø315 (metrics)<br>*ø315: Made to order | Cutting diameter ø80 to ø315 (inch spec)<br>Cutting diameter ø40 to ø315 (metrics)<br>*ø315: Made to order                            | Cutting diameter ø80 to ø250 (inch spec)<br>Cutting diameter ø40 to ø250 (metrics) | Cutting diameter ø40 to ø80  |



## Compatible with smaller machines

Lineup of coarse pitch ø40  
Works well on small machines such as BT30

Recommendation for small machines:  
Low cutting force SM  
Cutting resistance is about 10% less than general-purpose GM

## Cutting resistance comparison (Internal evaluation)

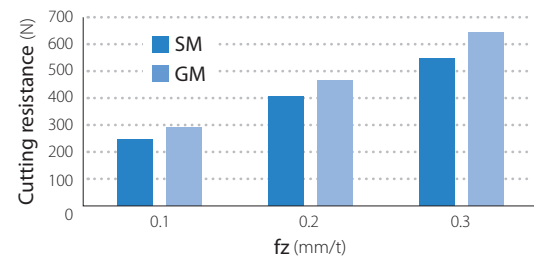

Cutting Conditions: Vc = 150 m/min, ap = 1.0 mm, ae/Dc = 80 %, Dry, BT50  
Workpiece: S50C

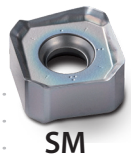

## Case studies

### Excellent performance even under unstable machining conditions

#### Cradle SS400

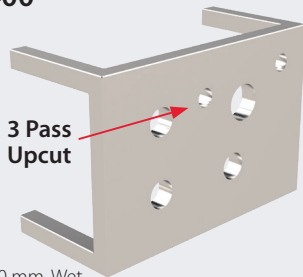

Vc = 160 m/min  
ap x ae = 0.07x130 mm, Wet

#### Machining efficiency

**MB45** ø160 12 inserts  
GM(PR1825)

**Vf = 760 mm/min**  
fz = 0.20 mm/t

Competitor G ø160 8 inserts

**Vf = 620 mm/min**  
fz = 0.25 mm/t

#### Machining efficiency

1.2x

MB45 shows stable machining in an environment prone to deflection and chatter. Increasing the number of inserts improves efficiency. Highly rated for quiet machining Improved joints between machining passes

(User evaluation)

## Case studies

### Achieves 1.6x longer tool life under the same machining conditions

#### Housing SUS316

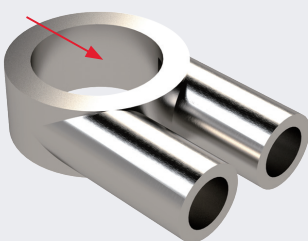

Vc = 90 m/min  
ap = 2.0 mm, fz = 0.18 mm/t, Dry

#### Number of parts

**MB45** ø63 5 inserts  
GM(PR1825)

**30 pcs per corner**

Competitor H ø63 5 inserts

**18 pcs per corner**

#### Tool life

1.6x

MB45 shows stable machining without chattering  
Wear on the cutting edge proceeds normally and shows 1.6x tool life than competitor.







(User evaluation)

# Recommended Cutting Conditions ★ 1st Recommendation ☆ 2nd Recommendation

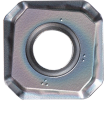
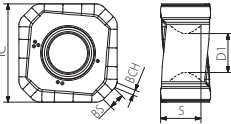
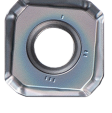
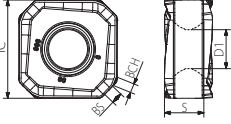
| Chipbreaker          | Workpiece   | Feed fz (mm/t)   | Recommended Insert Grade (Vc: m/min) |                             |                             |                             |                             |                             |                             |         |
|----------------------|---|--|--------------------------------------|-----------------------------|-----------------------------|-----------------------------|-----------------------------|-----------------------------|-----------------------------|---------|
|                      |   |  | MEGACOAT NANO EX (PVD coating)       |                             |                             | MEGACOAT HARD (PVD coating) | CVD coating                 | Cermet                      | DLC coating                 | Carbide |
|                      |   |  | PR1835                               | PR1825                      | PR1810                      | PR015S                      | CA6535                      | TN620M                      | PDL025                      | GW25    |
| General GM           | Carbon Steel (SxxC)                                     | 0.1 – <b>0.2</b> – 0.4<br>(0.06 – <b>0.12</b> – 0.20)  | ☆<br>120 – <b>180</b> – 250          | ★<br>120 – <b>180</b> – 250 | –                           | –                           | –                           | ★<br>200 – <b>250</b> – 300 | –                           | –       |
|                      | Alloy Steel (SCM, etc.)                                 | 0.1 – <b>0.2</b> – 0.4<br>(0.06 – <b>0.12</b> – 0.20)  | ☆<br>100 – <b>160</b> – 220          | ★<br>100 – <b>160</b> – 220 | –                           | –                           | –                           | ★<br>180 – <b>220</b> – 250 | –                           | –       |
|                      | Mold steel (SKD, etc.)                                  | 0.1 – <b>0.2</b> – 0.35<br>(0.06 – <b>0.08</b> – 0.15) | ☆<br>80 – <b>140</b> – 180           | ★<br>80 – <b>140</b> – 180  | –                           | –                           | –                           | ★<br>150 – <b>180</b> – 220 | –                           | –       |
|                      | Austenitic stainless steel (SUS 304, etc.)              | 0.1 – <b>0.2</b> – 0.4                                 | ☆<br>100 – <b>160</b> – 200          | ☆<br>100 – <b>160</b> – 200 | –                           | –                           | –                           | –                           | –                           | –       |
|                      | Martensitic stainless steel (SUS 403, etc.)             | 0.1 – <b>0.2</b> – 0.4                                 | ☆<br>150 – <b>200</b> – 250          | –                           | –                           | –                           | ☆<br>180 – <b>240</b> – 300 | –                           | –                           | –       |
|                      | Precipitation hardening stainless steel (SUS 630, etc.) | 0.1 – <b>0.2</b> – 0.3                                 | ★<br>90 – <b>120</b> – 150           | –                           | –                           | –                           | –                           | –                           | –                           | –       |
|                      | Gray cast iron (FC)                                     | 0.1 – <b>0.2</b> – 0.4                                 | –                                    | –                           | ★<br>120 – <b>180</b> – 250 | –                           | –                           | –                           | –                           | –       |
|                      | Ductile cast iron (FCD)                                 | 0.1 – <b>0.2</b> – 0.35                                | –                                    | –                           | ★<br>100 – <b>150</b> – 200 | –                           | –                           | –                           | –                           | –       |
|                      | Ni-based heat resistant alloys                          | 0.1 – <b>0.12</b> – 0.2                                | ☆<br>20 – <b>30</b> – 50             | –                           | –                           | –                           | ★<br>20 – <b>30</b> – 50    | –                           | –                           | –       |
| Low Cutting Force SM | Carbon Steel (SxxC)                                     | 0.06 – <b>0.12</b> – 0.25                              | ☆<br>120 – <b>180</b> – 250          | ☆<br>120 – <b>180</b> – 250 | –                           | –                           | –                           | –                           | –                           | –       |
|                      | Alloy Steel (SCM, etc.)                                 | 0.06 – <b>0.12</b> – 0.25                              | ☆<br>100 – <b>160</b> – 220          | ☆<br>100 – <b>160</b> – 220 | –                           | –                           | –                           | –                           | –                           | –       |
|                      | Mold steel (SKD, etc.)                                  | 0.06 – <b>0.1</b> – 0.2                                | ☆<br>80 – <b>140</b> – 180           | ☆<br>80 – <b>140</b> – 180  | –                           | –                           | –                           | –                           | –                           | –       |
|                      | Austenitic stainless steel (SUS 304, etc.)              | 0.06 – <b>0.12</b> – 0.25                              | ★<br>100 – <b>160</b> – 200          | ☆<br>100 – <b>160</b> – 200 | –                           | –                           | –                           | –                           | –                           | –       |
|                      | Martensitic stainless steel (SUS 403, etc.)             | 0.06 – <b>0.12</b> – 0.25                              | ☆<br>150 – <b>200</b> – 250          | –                           | –                           | –                           | ★<br>180 – <b>240</b> – 300 | –                           | –                           | –       |
|                      | Precipitation hardening stainless steel (SUS 630, etc.) | 0.06 – <b>0.12</b> – 0.25                              | ☆<br>90 – <b>120</b> – 150           | –                           | –                           | –                           | –                           | –                           | –                           | –       |
|                      | Gray cast iron (FC)                                     | 0.06 – <b>0.12</b> – 0.25                              | –                                    | –                           | ☆<br>120 – <b>180</b> – 250 | –                           | –                           | –                           | –                           | –       |
|                      | Ductile cast iron (FCD)                                 | 0.06 – <b>0.1</b> – 0.2                                | –                                    | –                           | ☆<br>100 – <b>150</b> – 200 | –                           | –                           | –                           | –                           | –       |
|                      | Ni-based heat resistant alloys                          | 0.06 – <b>0.1</b> – 0.15                               | ☆<br>20 – <b>30</b> – 50             | –                           | –                           | –                           | ☆<br>20 – <b>30</b> – 50    | –                           | –                           | –       |
|                      | Titanium alloy (Ti-6Al-4V)                              | 0.06 – <b>0.08</b> – 0.15                              | ★<br>40 – <b>60</b> – 80             | –                           | –                           | –                           | –                           | –                           | –                           | –       |
| Tough Edge GH        | Carbon Steel (SxxC)                                     | 0.2 – <b>0.3</b> – 0.5                                 | ☆<br>120 – <b>180</b> – 250          | ☆<br>120 – <b>180</b> – 250 | –                           | –                           | –                           | –                           | –                           | –       |
|                      | Alloy Steel (SCM, etc.)                                 | 0.2 – <b>0.3</b> – 0.5                                 | ☆<br>100 – <b>160</b> – 220          | ☆<br>120 – <b>160</b> – 220 | –                           | –                           | –                           | –                           | –                           | –       |
|                      | Mold steel (SKD, etc.)                                  | 0.2 – <b>0.3</b> – 0.45                                | ☆<br>80 – <b>140</b> – 180           | ☆<br>80 – <b>140</b> – 180  | –                           | –                           | –                           | –                           | –                           | –       |
|                      | Austenitic stainless steel (SUS 304, etc.)              | 0.2 – <b>0.3</b> – 0.4                                 | ☆<br>100 – <b>160</b> – 200          | ☆<br>100 – <b>160</b> – 200 | –                           | –                           | –                           | –                           | –                           | –       |
|                      | Martensitic stainless steel (SUS 403, etc.)             | 0.2 – <b>0.3</b> – 0.4                                 | ☆<br>150 – <b>200</b> – 250          | –                           | –                           | –                           | ☆<br>180 – <b>240</b> – 300 | –                           | –                           | –       |
|                      | Precipitation hardening stainless steel (SUS 630, etc.) | 0.2 – <b>0.3</b> – 0.4                                 | ☆<br>90 – <b>120</b> – 150           | –                           | –                           | –                           | –                           | –                           | –                           | –       |
|                      | Gray cast iron (FC)                                     | 0.2 – <b>0.3</b> – 0.5                                 | –                                    | –                           | ☆<br>120 – <b>180</b> – 250 | –                           | –                           | –                           | –                           | –       |
|                      | Ductile cast iron (FCD)                                 | 0.2 – <b>0.3</b> – 0.45                                | –                                    | –                           | ☆<br>100 – <b>150</b> – 200 | –                           | –                           | –                           | –                           | –       |
|                      | Ni-based heat resistant alloys                          | 0.1 – <b>0.2</b> – 0.3                                 | ☆<br>20 – <b>30</b> – 50             | –                           | –                           | –                           | ☆<br>20 – <b>30</b> – 50    | –                           | –                           | –       |
|                      | Hardened material (40 HRC or less)                      | 0.05 – <b>0.1</b> – 0.2                                | –                                    | –                           | –                           | ★<br>50 – <b>80</b> – 100   | –                           | –                           | –                           | –       |
| AM                   | Aluminum alloy  | 0.1 – <b>0.2</b> – 0.4                                 | –                                    | –                           | –                           | –                           | –                           | ★<br>200 – <b>600</b> – 900 | ☆<br>200 – <b>500</b> – 800 | –       |

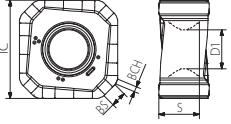
The number in bold font is recommended starting conditions. Adjust the cutting speed and the feed rate within the above conditions according to the actual machining situation. Machining with coolant is recommended for Ni-based heat resistant alloy and titanium alloy. When choosing wet machining for other workpieces, reduce the cutting speed to 70% or less. When machining aluminum, be sure to use within recommended conditions. Do not rotate more than the maximum speed listed on the main unit. Dry machining is recommended for cermet.

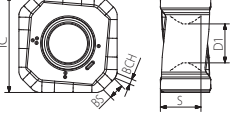
# Applicable Inserts

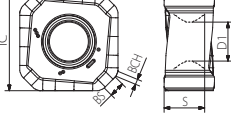
| Usage Classification  | P   | Steel                                   | ★    | ☆    |     |     |   |        | ■             |             |        |             |         |      |
|---|---|---|------|------|-----|-----|---|--------|---------------|-------------|--------|-------------|---------|------|
|   |   | Mold steel                              | ★    | ☆    |     |     |   |        | ■             |             |        |             |         |      |
| ★: Roughing/<br>1st recommendation<br>☆: Roughing/<br>2nd recommendation<br>■: Finishing/<br>1st recommendation<br>□: Finishing/<br>2nd recommendation<br>(Hardened material is 40 HRC or less) | M   | Austenitic stainless steel              | ☆    | ★    |     |     |   |        |               |             |        |             |         |      |
|   |   | Martensitic stainless steel             |      | ☆    |     |     |   | ★      |               |             |        |             |         |      |
|   |   | Precipitation hardening stainless steel |      | ★    |     |     |   |        |               |             |        |             |         |      |
|   | K   | Gray cast iron                          |      |      |     |     | ★   |        |               |             |        |             |         |      |
|   |   | Ductile cast iron                       |      |      |     |     | ★   |        |               |             |        |             |         |      |
| N   | Nonferrous metal  |   |      |      |     |     |   |        |               | ★           | ☆      |             |         |      |
| S   | Heat resistant alloys (Ni-based heat resistant alloys)                              |   |      |      |     |     |   |        | ★             |             |        |             |         |      |
|   | Titanium alloy  |   |      |      |     |     | ★   |        |               |             |        |             |         |      |
| H   | Hardened material   |   |      |      |     |     |   |        |               |             |        |             |         |      |
| Shape   | Description   | Dimensions (mm)                         |      |      |     |     | MEGACOAT NANO EX <span style="color:red">NEW</span> |        | MEGACOAT HARD | CVD coating | Cermet | DLC coating | Carbide |      |
|   |   | IC                                      | S    | BCH  | BS  | D1  | PR1825  | PR1835 | PR1810        | PR0155      | CA6535 | TN620M      | PDL025  | GW25 |
| <br>General Purpose (M-Class)  |    | SNMU1406ANER-GM                         | 14.7 | 6.07 | 0.8 | 2.3 | 5.8   | ●      | ●             | ●           | ●      | ●           |         |      |
| <br>Tough Edge (M-Class)  |   | SNMU1406ANER-GH                         | 14.7 | 5.89 | 1.4 | 1.7 | 5.8   | ●      | ●             | ●           | ●      | ●           |         |      |
| <br>General Purpose (E-Class)  |  | SNEU1406ANER-GM                         | 14.7 | 6.07 | 0.8 | 2.3 | 5.8   | ●      | ●             | ●           | ●      | ●           |         |      |
| <br>Low cutting force (E-Class)  |  | SNEU1406ANER-SM                         | 14.7 | 6.07 | 0.8 | 2.3 | 5.8   | ●      | ●             |             | ●      |             |         |      |
| <br>Aluminum and non-ferrous metals (E-Class)  |  | SNEU1406ANFR-AM                         | 14.7 | 6.07 | 0.8 | 2.3 | 5.8   |        |               |             |        |             | ●       | ●    |

●: Standard Stock

## Applicable Chipbreaker Range

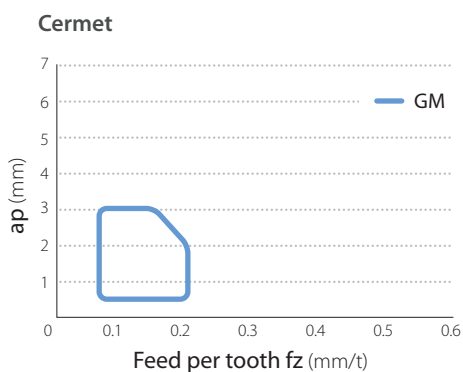
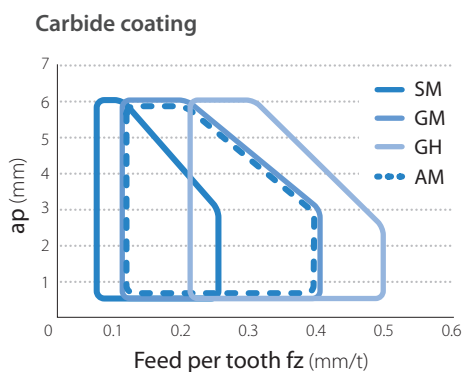

# MB45 Face mill

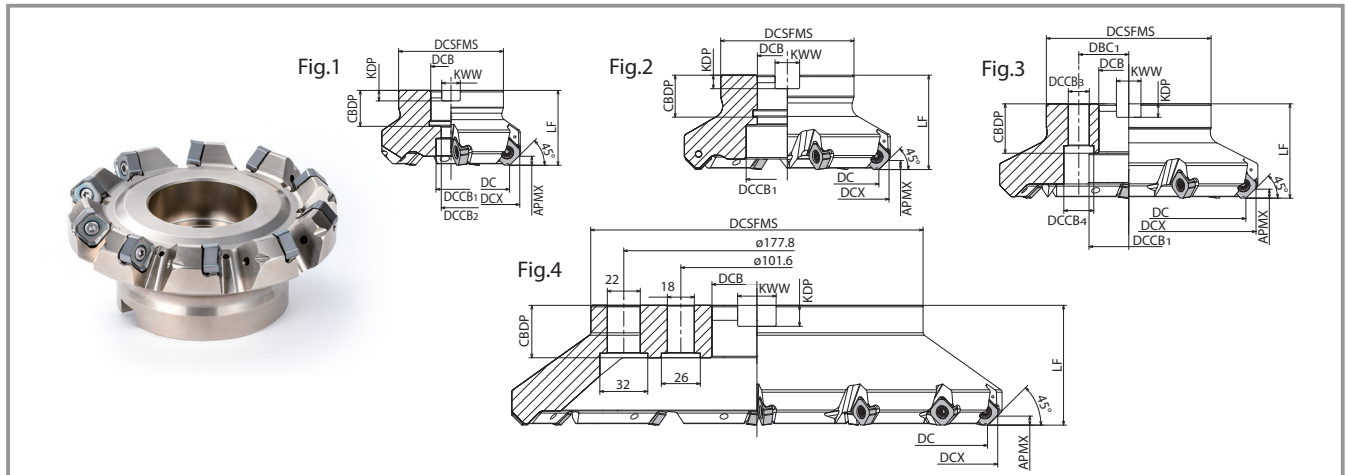

## Toolholder dimensions

| Description          | Stock             | Number of inserts | Dimensions (mm) |     |        |     |        |        |       |       |      |    |       |       |     | A.R. max.(°) | R.R.(°) | Coolant hole | Weight (kg) | Maximum number of revolutions (min <sup>-1</sup> ) | Shape |       |       |       |       |
|----------------------|-------------------|-------------------|-----------------|-----|--------|-----|--------|--------|-------|-------|------|----|-------|-------|-----|--------------|---------|--------------|-------------|--|-------|-------|-------|-------|-------|
|                      |                   |                   | DC              | DCX | DCSFMS | DCB | DCCB1  | DCCB2  | DCCB3 | DCCB4 | DBC1 | LF | CBDP  | KDP   | KWW |              |         |              |             |  |       | APMX  |       |       |       |
| Bore Dia. Inch spec. | Coarse Pitch      | MB45 - 080R-14T5C | ●               | 5   | 80     | 93  | 70     | 25.4   | 20    | 13    |      |    |       |       |     | 50           | 27      | 6            | 9.5         |  |       | 1.4   | 9,000 | Fig.1 |       |
|                      |                   | 100R-14T5C        | ●               | 5   | 100    | 113 | 78     | 31.75  | 45    |       |      |    |       |       |     | 34           | 8       | 12.7         |             | Yes  | 2.0   | 8,000 | Fig.2 |       |       |
|                      |                   | 125R-14T6C        | ●               | 6   | 125    | 138 | 89     | 38.1   | 55    |       |      |    |       |       |     |              |         | 10           | 15.9        |  | 3.3   | 7,200 |       |       |       |
|                      |                   | 160R-14T7         | ●               | 7   | 160    | 173 | 110    | 50.8   | 70    |       |      |    |       |       |     |              |         |              | 11          | 19.1   | 6     | 13    | -12   | 5.1   | 6,300 |
|                      |                   | 200R-14T8         | ●               | 8   | 200    | 213 | 140    | 47.625 | 110   |       |      | 18 | 26    | 101.6 |     | 63           | 38      | 14           | 25.4        |  | No    | 7.6   | 5,700 | Fig.3 |       |
|                      |                   | 250R-14T10        | ●               | 10  | 250    | 263 |        |        |       |       |      |    |       |       |     |              |         |              |             |  |       | 10.8  | 5,100 |       |       |
|                      | 315R-14T14        | MTO               | 14              | 315 | 328    | 222 |        |        |       |       |      |    |       |       | 80  |              |         |              |             |  | 20.4  | 4,500 | Fig.4 |       |       |
|                      | Fine Pitch        | MB45 - 080R-14T6C | ●               | 6   | 80     | 93  | 70     | 25.4   | 20    | 13    |      |    |       |       |     | 50           | 27      | 6            | 9.5         |  |       | 1.4   | 9,000 | Fig.1 |       |
|                      |                   | 100R-14T8C        | ●               | 8   | 100    | 113 | 78     | 31.75  | 45    |       |      |    |       |       |     | 34           | 8       | 12.7         |             | Yes  | 1.8   | 8,000 | Fig.2 |       |       |
|                      |                   | 125R-14T10C       | ●               | 10  | 125    | 138 | 89     | 38.1   | 55    |       |      |    |       |       |     |              |         | 10           | 15.9        |  | 3.1   | 7,200 |       |       |       |
|                      |                   | 160R-14T12        | ●               | 12  | 160    | 173 | 110    | 50.8   | 70    |       |      |    |       |       |     |              |         |              | 11          | 19.1   | 6     | 13    | -12   | 4.9   | 6,300 |
|                      |                   | 200R-14T14        | ●               | 14  | 200    | 213 | 140    | 47.625 | 110   |       |      | 18 | 26    | 101.6 |     | 63           | 38      | 14           | 25.4        |  | No    | 7.4   | 5,700 | Fig.3 |       |
| 250R-14T16           |                   | ●                 | 16              | 250 | 263    |     |        |        |       |       |      |    |       |       |     |              |         |              |             |  | 10.5  | 5,100 |       |       |       |
| 315R-14T18           | MTO               | 18                | 315             | 328 | 222    |     |        |        |       |       |      |    |       | 80    |     |              |         |              |             | 20.2   | 4,500 | Fig.4 |       |       |       |
| Extra Fine Pitch     | MB45 - 080R-14T8C | ●                 | 8               | 80  | 93     | 70  | 25.4   | 20     | 13    |       |      |    |       |       | 50  | 27           | 6       | 9.5          |             |  | 1.3   | 9,000 | Fig.1 |       |       |
|                      | 100R-14T10C       | ●                 | 10              | 100 | 113    | 78  | 31.75  | 45     |       |       |      |    |       |       | 34  | 8            | 12.7    |              | -12         | Yes  | 1.8   | 8,000 | Fig.2 |       |       |
|                      | 125R-14T13C       | ●                 | 13              | 125 | 138    | 89  | 38.1   | 55     |       |       |      |    |       |       |     |              | 10      | 15.9         |             | 3.0  | 7,200 |       |       |       |       |
|                      | 160R-14T16        | ●                 | 16              | 160 | 173    | 110 | 50.8   | 70     |       |       |      |    |       |       |     |              |         | 11           | 19.1        | 6  | 13    | -13   | 4.8   | 6,300 |       |
|                      | 200R-14T18        | ●                 | 18              | 200 | 213    | 140 | 47.625 | 110    |       |       | 18   | 26 | 101.6 |       | 63  | 38           | 14      | 25.4         |             | No   | 7.2   | 5,700 | Fig.3 |       |       |
|                      | 250R-14T20        | ●                 | 20              | 250 | 263    |     |        |        |       |       |      |    |       |       |     |              |         |              |             |  | 10.4  | 5,100 |       |       |       |

### Maximum number of revolutions

Set the number of revolutions per minute within the recommended cutting speed specified by the workpiece on page 10.

Do not use the face mill or shank type at the maximum revolution or higher since the centrifugal force may cause chips and parts to scatter even under no load.

●: Standard Stock MTO: Made to order

## Parts

| Description | Parts       |        |                     |                  |
|-------------|-------------|--------|---------------------|------------------|
|             | Clamp screw | Wrench | Anti-seize compound | Arbor clamp bolt |
| Face mill   | SB-50110TRP | TTP-20 | P-37                | HH8X25           |
|             |             |        |                     | HH10X30          |
|             |             |        |                     | HH10X30          |
|             |             |        |                     | HH12X35          |
|             |             |        |                     | -                |
| Shank Type  | SB-50110TRP | TTP-20 | P-37                | -                |
|             |             |        |                     | -                |
|             |             |        |                     | -                |
|             |             |        |                     | -                |

Coat anti-seize compound thinly on portion of taper and thread prior to installation.

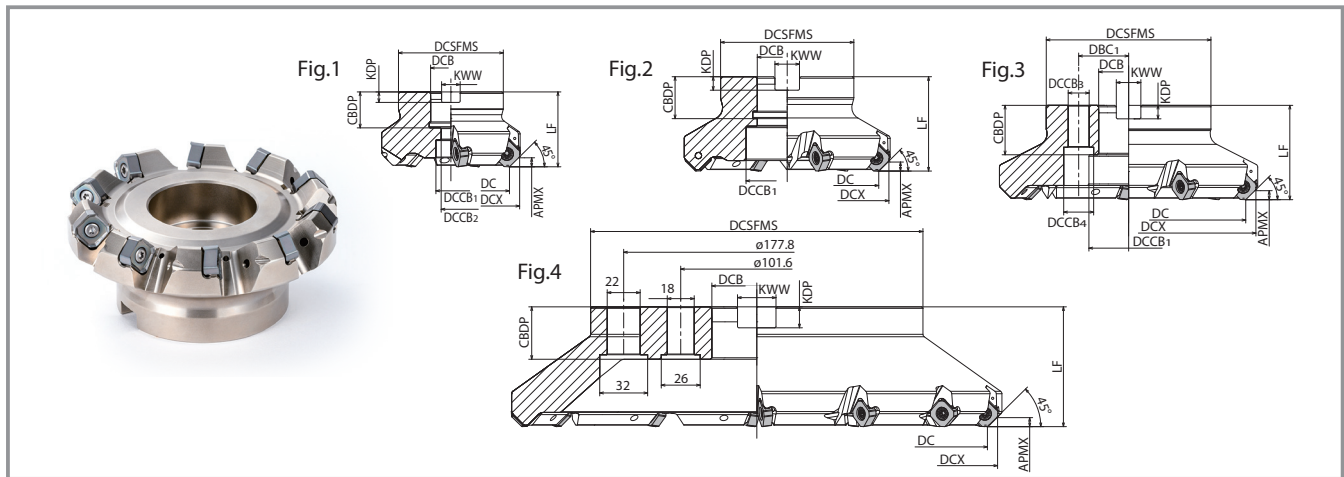

Toolholder dimensions

| Description      | Stock               | Number of inserts   | Dimensions (mm) |     |        |     |       |       |       |       |      |       |       |     |     | A.R. max (°) | R.R. (°) | Coolant hole | Weight (kg) | Maximum number of revolutions (min <sup>-1</sup> ) | Shape  |        |
|------------------|---------------------|---------------------|-----------------|-----|--------|-----|-------|-------|-------|-------|------|-------|-------|-----|-----|--------------|----------|--------------|-------------|--|--------|--------|
|                  |                     |                     | DC              | DCX | DCSFMS | DCB | DCCB1 | DCCB2 | DCCB3 | DCCB4 | DBC1 | LF    | CBDP  | KDP | KWW |              |          |              |             |  |        | APMX   |
| Coarse Pitch     | MB45 - 040R-14T2C-M | ●                   | 2               | 40  | 53     | 38  | 16    | 13.5  | 9     | -     | -    | -     | -     | -   | 19  | 5.6          | 8.4      | Yes          | 0.4         | 12,700   | Fig.1  |        |
|                  | 050R-14T3C-M        | ●                   | 3               | 50  | 63     | 48  | 22    | 18    | 11    | -     | -    | -     | -     | 40  | 21  | 6.3          | 10.4     |              | 0.5         | 11,400   |        |        |
|                  | 063R-14T4C-M        | ●                   | 4               | 63  | 76     | 50  | -     | -     | -     | -     | -    | -     | -     | 50  | 24  | 7            | 12.4     |              | 0.7         | 10,100   |        |        |
|                  | 080R-14T5C-M        | ●                   | 5               | 80  | 93     | 70  | 27    | 20    | 13    | -     | -    | -     | -     | 50  | 30  | 8            | 14.4     | 1.4          | 9,000       | Fig.2  |        |        |
|                  | 100R-14T5C-M        | ●                   | 5               | 100 | 113    | 78  | 32    | 45    | -     | -     | -    | -     | -     | 50  | 30  | 8            | 14.4     | 1.9          | 8,000       |  |        |        |
|                  | 125R-14T6C-M        | ●                   | 6               | 125 | 138    | 89  | 40    | 55    | -     | -     | -    | -     | -     | 63  | 33  | 9            | 16.4     | 3.2          | 7,200       | Fig.3  |        |        |
|                  | 160R-14T7-M         | ●                   | 7               | 160 | 173    | 110 | -     | -     | -     | 14    | 20   | 66.7  | -     | 63  | 33  | 9            | 16.4     | 5.1          | 6,300       |  |        |        |
|                  | 200R-14T8-M         | ●                   | 8               | 200 | 213    | 142 | 60    | 110   | -     | -     | -    | -     | -     | 63  | 35  | 14           | 25.7     | 7.3          | 5,700       | Fig.4  |        |        |
|                  | 250R-14T10-M        | ●                   | 10              | 250 | 263    | 142 | 60    | 110   | -     | 18    | 26   | 101.6 | -     | 63  | 35  | 14           | 25.7     | 10.5         | 5,100       |  |        |        |
| 315R-14T14-M     | MTO                 | 14                  | 315             | 328 | 222    | -   | -     | -     | -     | -     | -    | -     | 80    | 80  | 14  | 25.7         | 19.4     | 4,500        | Fig.4       |  |        |        |
| Metric           | Fine Pitch          | MB45 - 040R-14T3C-M | ●               | 3   | 40     | 53  | 38    | 16    | 13.5  | 9     | -    | -     | -     | -   | 19  | 5.6          | 8.4      | Yes          | 0.3         | 12,700   | Fig.1  |        |
|                  |                     | 050R-14T4C-M        | ●               | 4   | 50     | 63  | 48    | 22    | 18    | 11    | -    | -     | -     | -   | 40  | 21           | 6.3      |              | 10.4        | 0.4  |        | 11,400 |
|                  |                     | 063R-14T5C-M        | ●               | 5   | 63     | 76  | 50    | -     | -     | -     | -    | -     | -     | -   | 50  | 24           | 7        |              | 12.4        | 0.6  |        | 10,100 |
|                  |                     | 080R-14T6C-M        | ●               | 6   | 80     | 93  | 70    | 27    | 20    | 13    | -    | -     | -     | -   | 50  | 30           | 8        | 14.4         | 1.4         | 9,000  | Fig.2  |        |
|                  |                     | 100R-14T8C-M        | ●               | 8   | 100    | 113 | 78    | 32    | 45    | -     | -    | -     | -     | -   | 50  | 30           | 8        | 14.4         | 1.8         | 8,000  |        |        |
|                  |                     | 125R-14T10C-M       | ●               | 10  | 125    | 138 | 89    | 40    | 55    | -     | -    | -     | -     | -   | 63  | 33           | 9        | 16.4         | 3.0         | 7,200  | Fig.3  |        |
|                  |                     | 160R-14T12-M        | ●               | 12  | 160    | 173 | 110   | -     | -     | -     | 14   | 20    | 66.7  | -   | 63  | 33           | 9        | 16.4         | 4.9         | 6,300  |        |        |
|                  |                     | 200R-14T14-M        | ●               | 14  | 200    | 213 | 142   | 60    | 110   | -     | -    | -     | -     | -   | 63  | 35           | 14       | 25.7         | 7.0         | 5,700  | Fig.4  |        |
|                  |                     | 250R-14T16-M        | ●               | 16  | 250    | 263 | 142   | 60    | 110   | -     | 18   | 26    | 101.6 | -   | 63  | 35           | 14       | 25.7         | 10.2        | 5,100  |        |        |
| 315R-14T18-M     | MTO                 | 18                  | 315             | 328 | 222    | -   | -     | -     | -     | -     | -    | -     | 80    | 80  | 14  | 25.7         | 19.2     | 4,500        |             |  |        |        |
| Extra Fine Pitch | MB45 - 040R-14T4C-M | ●                   | 4               | 40  | 53     | 38  | 16    | 13.5  | 9     | -     | -    | -     | -     | 19  | 5.6 | 8.4          | Yes      | 0.3          | 12,700      | Fig.1  |        |        |
|                  | 050R-14T5C-M        | ●                   | 5               | 50  | 63     | 48  | 22    | 18    | 11    | -     | -    | -     | -     | 40  | 21  | 6.3          |          | 10.4         | 0.4         |  | 11,400 |        |
|                  | 063R-14T6C-M        | ●                   | 6               | 63  | 76     | 50  | -     | -     | -     | -     | -    | -     | -     | 50  | 24  | 7            |          | 12.4         | 0.6         |  | 10,100 |        |
|                  | 080R-14T8C-M        | ●                   | 8               | 80  | 93     | 70  | 27    | 20    | 13    | -     | -    | -     | -     | 50  | 30  | 8            | 14.4     | 1.3          | 9,000       | Fig.2  |        |        |
|                  | 100R-14T10C-M       | ●                   | 10              | 100 | 113    | 78  | 32    | 45    | -     | -     | -    | -     | -     | 50  | 30  | 8            | 14.4     | 1.7          | 8,000       |  |        |        |
|                  | 125R-14T13C-M       | ●                   | 13              | 125 | 138    | 89  | 40    | 55    | -     | -     | -    | -     | -     | 63  | 33  | 9            | 16.4     | 2.9          | 7,200       | Fig.3  |        |        |
|                  | 160R-14T16-M        | ●                   | 16              | 160 | 173    | 110 | -     | -     | -     | 14    | 20   | 66.7  | -     | 63  | 33  | 9            | 16.4     | 4.8          | 6,300       |  |        |        |
|                  | 200R-14T18-M        | ●                   | 18              | 200 | 213    | 142 | 60    | 110   | -     | -     | -    | -     | -     | 63  | 35  | 14           | 25.7     | 6.9          | 5,700       | Fig.4  |        |        |
|                  | 250R-14T20-M        | ●                   | 20              | 250 | 263    | 142 | 60    | 110   | -     | 18    | 26   | 101.6 | -     | 63  | 35  | 14           | 25.7     | 10.1         | 5,100       |  |        |        |

Maximum number of revolutions

Set the number of revolutions per minute within the recommended cutting speed specified by the workpiece on page 10.

Do not use the face mill or shank type at the maximum revolution or higher since the centrifugal force may cause chips and parts to scatter even under no load.

● Standard Stock MTO: Made to order

# MB45 Shank Type

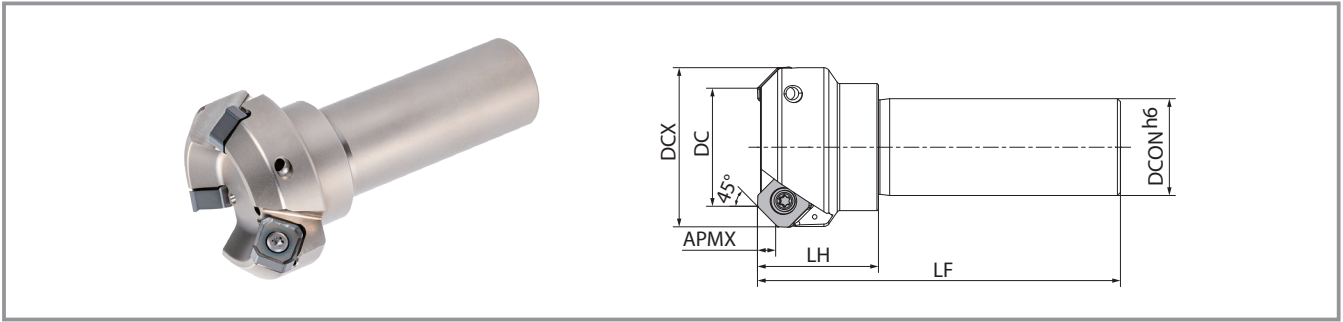

## Toolholder dimensions

|       | Stock       | Number of inserts | Dimensions (mm) |     |      |    | A.R. max.(°) | R.R.(°) | Coolant hole | Weight (kg) | Maximum number of revolutions (min <sup>-1</sup> ) |     |      |        |
|-------|-------------|-------------------|-----------------|-----|------|----|--------------|---------|--------------|-------------|--|-----|------|--------|
|       |             |                   | DC              | DCX | DCON | LH |              |         |              |             |  | LF  | APMX |        |
| MB45- | 40S32-14T2C | ●                 | 2               | 40  | 53   | 32 | 40           | 120     | 6            | 13          | -12  | Yes | 0.9  | 12,700 |
|       | 50S32-14T3C | ●                 | 3               | 50  | 63   |    |              |         |              |             |  |     | 1.0  | 11,400 |
|       | 63S32-14T4C | ●                 | 4               | 63  | 76   |    |              |         |              |             |  |     | 1.1  | 10,100 |
|       | 80S32-14T5C | ●                 | 5               | 80  | 93   |    |              |         |              |             |  |     | 1.5  | 9,000  |

### Maximum number of revolutions

Set the number of revolutions per minute within the recommended cutting speed specified by the workpiece on page 10. Do not use the face mill or shank type at the maximum revolution or higher since the centrifugal force may cause chips and parts to scatter even under no load.

●: Standard Stock

## Precautions

### Applications

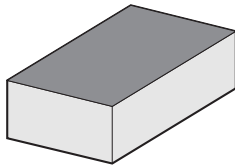

Facing

### How to mount inserts

1. Completely eliminate chips and dust from the insert mounting side.
2. Coat anti-seize compound thinly on portion of taper and thread of clamp screw prior to installation.
3. After mounting a clamp screw on the top edge of wrench, tighten the screw while keeping the insert pushed against the shim seat surface and holder surface (Fig.1).
4. Tighten the wrench in a direction parallel to the clamp screw.  
Recommended tightening torque ... 4.5 N·m
5. After tightening, check that there is no gap between the contact surface of the insert and the surface of the shim, or between the side surface of insert and the holder surface.

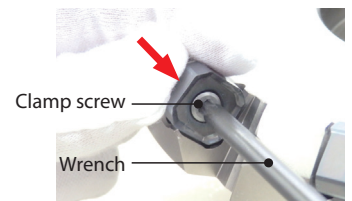

Fig.1

### Defining the Machining Diameter (DC)

With respect to the machining diameter (DC) specified in ISO\*, the numerical value of the machining diameter (Fig. 2) where the plane surface is finished depends on the insert. Please be careful.

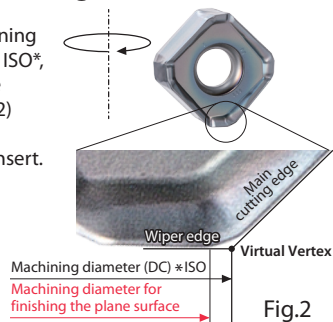

Fig.2

Machining diameter at which the plane surface is finished (for ø125mm)

|  | GM        | GH    | SM    | AM    |
|--|-----------|-------|-------|-------|
| Difference to machining diameter (DC)                          | -1.1      | -2.0  | -1.1  | -1.1  |
| Machining diameter (mm) at which the plane surface is finished | 123.9     | 123.0 | 123.9 | 123.9 |
| *Dimensional tolerance   | 0<br>-0.2 |       |       |       |

\*GH has a larger double-edge size, so the machining diameter at which the plane surface is finished is smaller than other inserts.

### Precautions when machining

#### Precautions when machining aluminum

- Be sure to use within recommended conditions.
- Do not rotate more than the maximum speed listed on the main unit.  
\*The number of revolutions listed on the holder is the maximum number of revolutions without load.

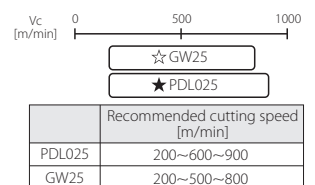

#### Precautions for wet machining of steel

For wet machining, select PR1835 and use a cutting speed of 70% or less of the recommended condition as a guide.

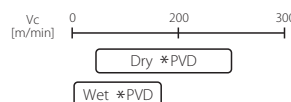

MB45-125R-14T10C

SCREW:SB-50110TRP WRENCH:

MAX 7,200 RPM

Rotating at maximum speed is prohibited.



C  
Chemical Vapor Deposition  
V  
D

CVD  
TECHNOLOGY

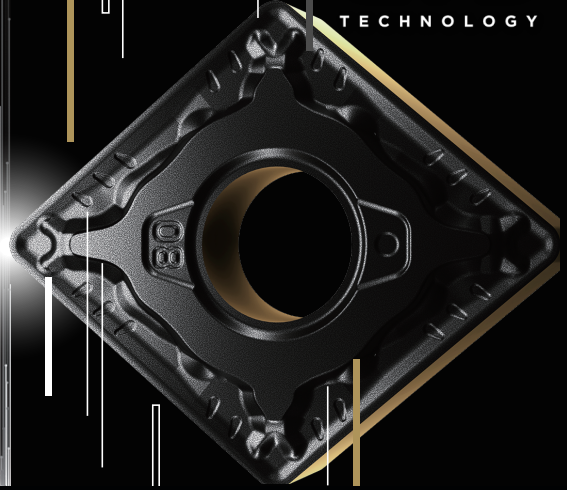

# Achieving Unprecedented Tool Life

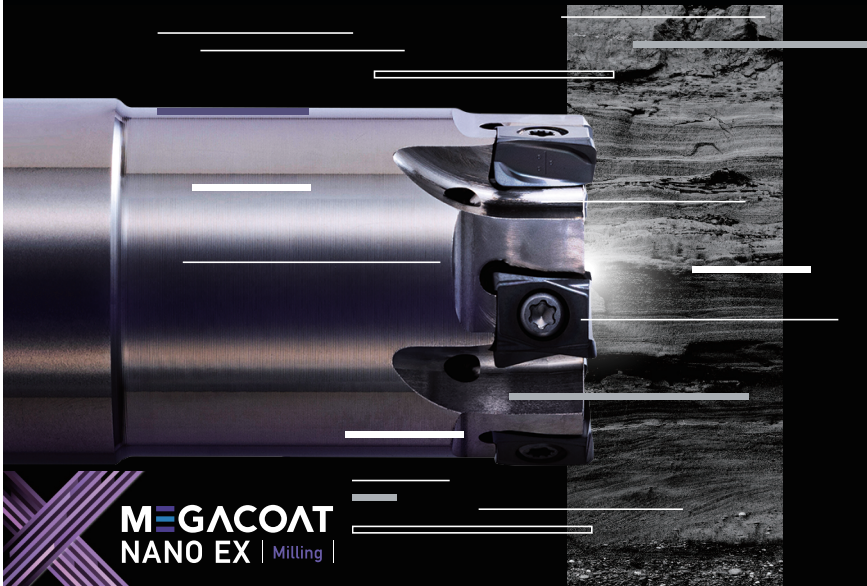

P  
Physical Vapor Deposition  
V  
D